

© 2007 COX ENGINEERING DBA CAMBRIDGEPORT AIR SYSTEMS.
 THE INFORMATION CONTAINED IN THIS DOCUMENT IS PROPRIETARY TO
 COX ENGINEERING COMPANY DBA CAMBRIDGEPORT AIR SYSTEMS.
 THIS DOCUMENT OR THE INFORMATION CONTAINED IN WHOLE OR IN PART
 MAY NOT BE ISSUED TO ANOTHER PARTY WITHOUT WRITTEN CONSENT AND
 AUTHORIZATION FROM CAMBRIDGEPORT.

Approval Block

Date: _____
 Company: _____
 Job Name: _____
 Approved By: _____
 Notes: _____

ENERGY WALL CURB SUBMITTAL # 1028895

ENERGY WALL U-ERV-5400 24" Tall

1028895

Drawn Date: 3/31/20 Rev.

Drawn By: JCJ

Estimated Weight: 352 LBS.

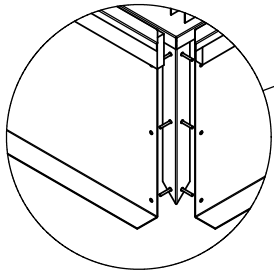
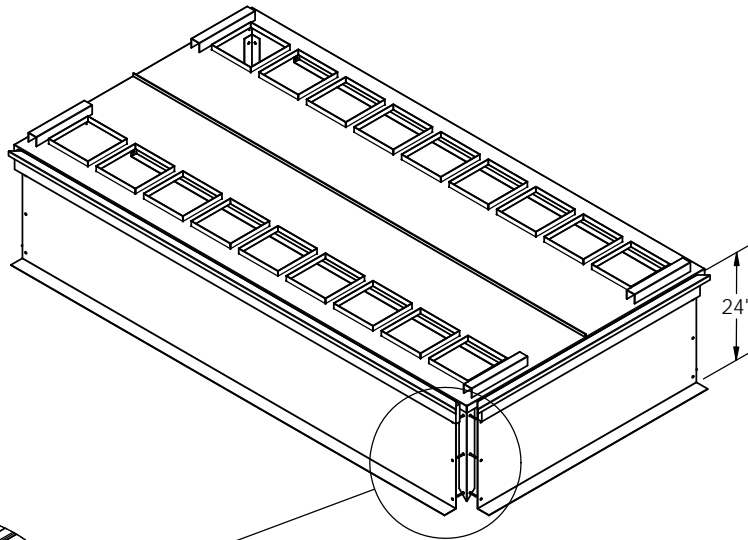

DETAIL A

FEATURES:

1. Mitered Corners.
2. Gasketing Provided for Unit to Curb Sealing.
3. Roof Curb is Fabricated of Heavy Gauge Galvanized Steel.
4. Full Perimeter Wood Nailer.
5. Pre-Punched Holes and Hardware Included for Curb Assembly.
6. Roof Curb is Shipped Knocked Down.
7. Roof Curb is Labeled with RTU # if Applicable.

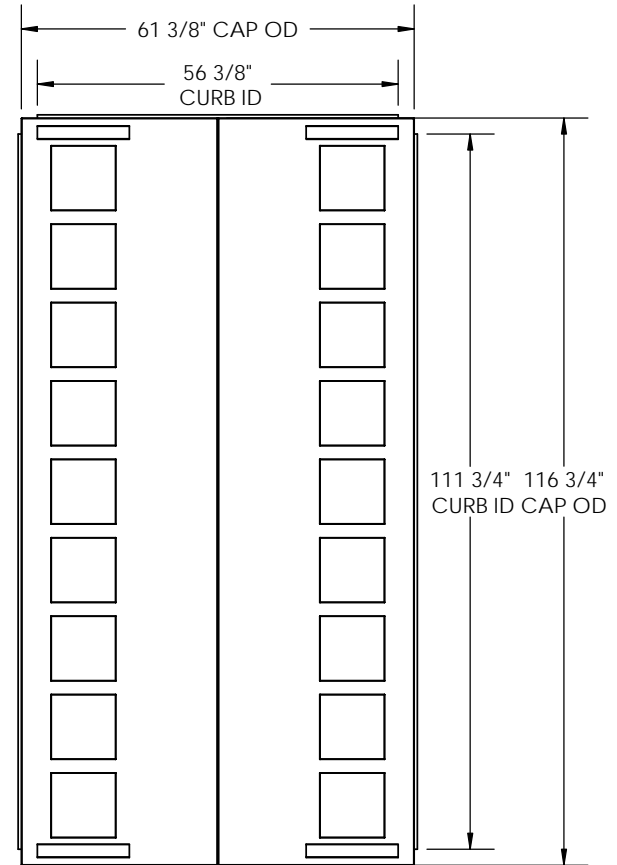
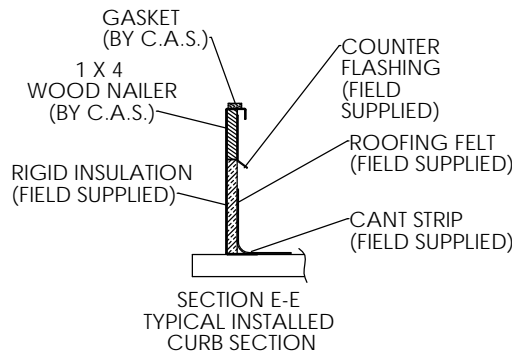

Cambridgeport

Cambridgeport
 4 Carleton Drive
 Georgetown, MA 01833

1-800-648-2872

1-877-648-2872

HVAC Accessories & Engineered Systems