

© 2007 COX ENGINEERING DBA CAMBRIDGEPORT AIR SYSTEMS.  
 THE INFORMATION CONTAINED IN THIS DOCUMENT IS PROPRIETARY TO  
 COX ENGINEERING COMPANY DBA CAMBRIDGEPORT AIR SYSTEMS.  
 THIS DOCUMENT OR THE INFORMATION CONTAINED IN WHOLE OR IN PART  
 MAY NOT BE ISSUED TO ANOTHER PARTY WITHOUT WRITTEN CONSENT AND  
 AUTHORIZATION FROM CAMBRIDGEPORT.

**Approval Block**

Date: \_\_\_\_\_  
 Company: \_\_\_\_\_  
 Job Name: \_\_\_\_\_  
 Approved By: \_\_\_\_\_  
 Notes: \_\_\_\_\_

# ENERGY WALL CURB SUBMITTAL # 1028528

ENERGY WALL U-ERV-3000 24" Tall

**1028528**

Drawn Date: 3/31/20 Rev.

Drawn By: JCJ

**Estimated Weight: 238 LBS.**

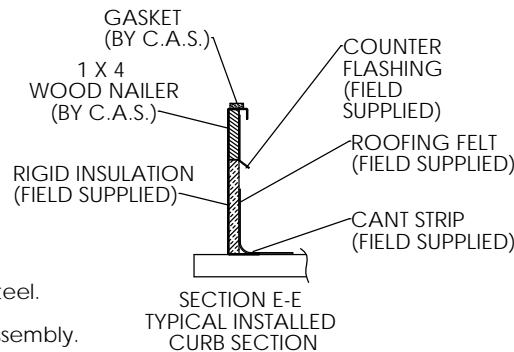
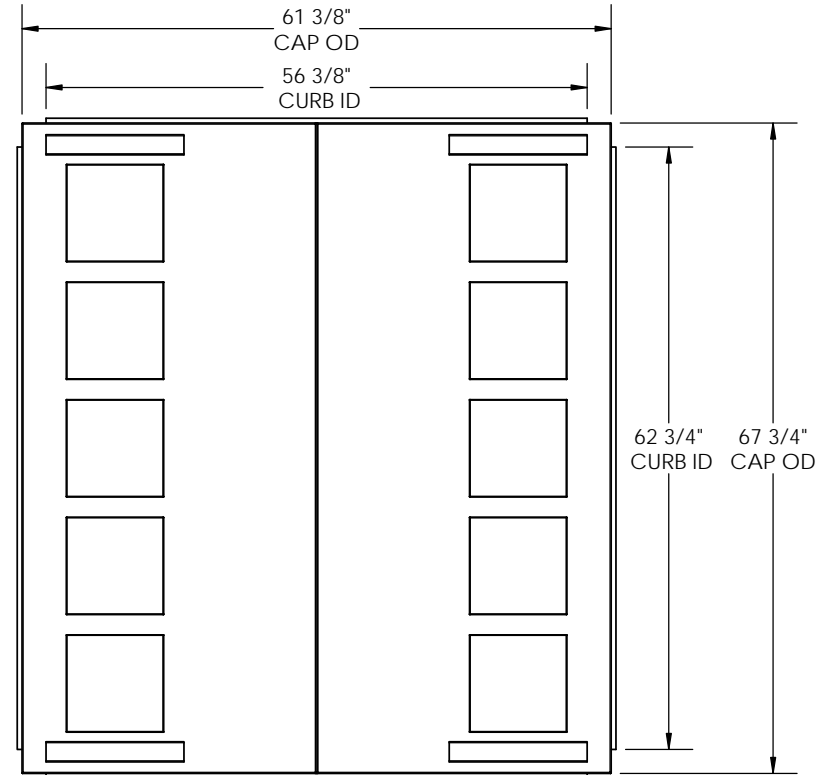
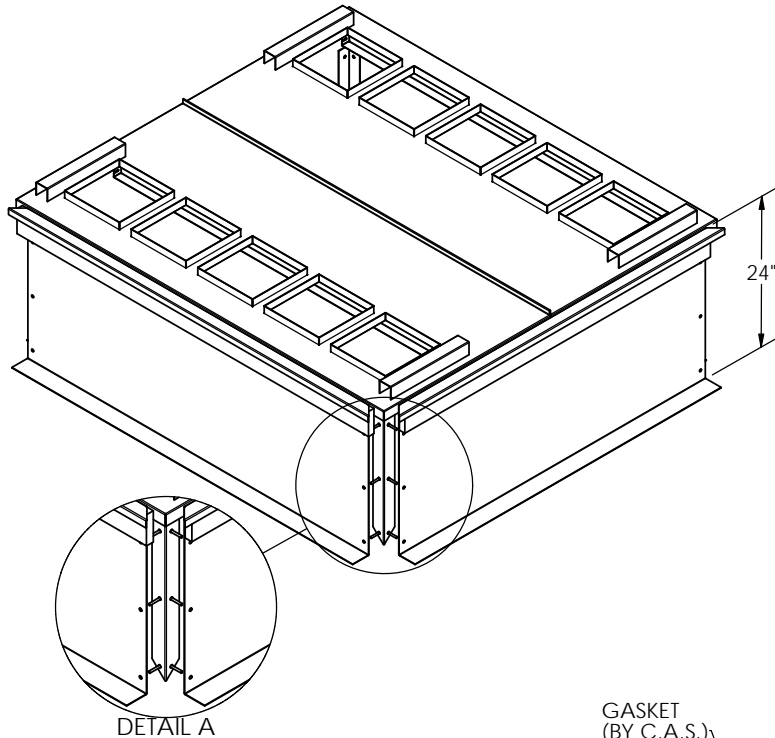

**FEATURES:**

1. Mitered Corners.
2. Gasketing Provided for Unit to Curb Sealing.
3. Roof Curb is Fabricated of Heavy Gauge Galvanized Steel.
4. Full Perimeter Wood Nailer.
5. Pre-Punched Holes and Hardware Included for Curb Assembly.
6. Roof Curb is Shipped Knocked Down.
7. Roof Curb is Labeled with RTU # if Applicable.

**Cambridgeport**

Cambridgeport  
 4 Carleton Drive  
 Georgetown, MA 01833

1-800-648-2872

1-877-648-2872

**HVAC Accessories & Engineered Systems**